

Emergency Signs and Escape Routes

Products to meet NZBC Clause F8 Signs and Clause F6 Visibility in Escape Routes



www.ecoglo.co.nz



Face Mounted Emergency Exit Signs to meet NZBC F8



Exit
Exit straight on from here
Maximum Viewing Distance: 16 metres
Product No: S20-EX2313-16m
Size 230mm x 133mm



Exit
Exit straight on from here
Maximum Viewing Distance: 24 metres
Product No: S20-EX2916-24m
Size 290mm x 162mm

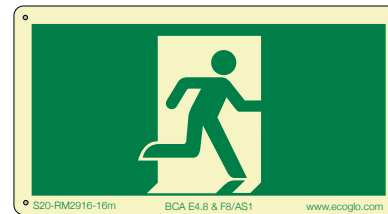

Pictogram
Exit straight on from here
Maximum Viewing Distance: 16 metres
Product No: S20-RM2916-16m
Size 290mm x 162mm



Pictogram
Exit straight on from here
Maximum Viewing Distance: 24 metres
Product No: S20-RM4223-24m
Size 420mm x 230mm



Pictogram Uni
Exit straight on from here
Maximum Viewing Distance: 16 metres
Product No: S20-RM1616UN-16m
Size 162mm x 162mm



Pictogram Uni
Exit straight on from here
Maximum Viewing Distance: 24 metres
Product No: S20-RM2323UN-24m
Size 230mm x 230mm



Pictogram Hi Vis
Exit straight on from here
Maximum Viewing Distance: 16 metres
Product No: S20-RM2916HV-16m
Size 290mm x 162mm

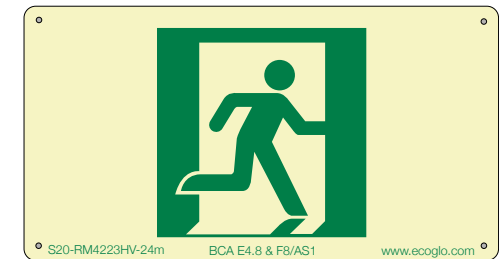

Pictogram Hi Vis
Exit straight on from here
Maximum Viewing Distance: 24 metres
Product No: S20-RM4223HV-24m
Size 420mm x 230mm

Face Mounted Emergency Exit Signs to meet NZBC F8

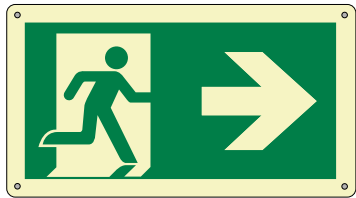

Pictogram Right

Exit right from here

Maximum Viewing Distance: 16 metres

Product No: S20-RMR2916-16m

Double Sided DSS20-RMD2916-16m

Size 290mm x 162mm



Pictogram Right

Exit right from here

Maximum Viewing Distance: 24 metres

Product No: S20-RMR4223-24m

Double Sided DSS20-RMD4223-24m

Size 420mm x 230mm



Emergency Exit

Use this door only to exit in an emergency

Maximum Viewing Distance: 16 metres

Product No: S20-EE6128-16m

Size 610mm x 280mm



Pictogram Left

Exit left from here

Maximum Viewing Distance: 16 metres

Product No: S20-RML2916-16m

Double Sided DSS20-RMD2916-16m

Size 290mm x 162mm



Pictogram Left

Exit left from here

Maximum Viewing Distance: 24 metres

Product No: S20-RML4223-24m

Double Sided DSS20-RMD4223-24m

Size 420mm x 230mm



Emergency Exit

Use this door only to exit in an emergency

Maximum Viewing Distance: 24 metres

Product No: S20-EE7835-24m

Size 785mm x 350mm

Face Mounted Emergency Exit Signs to meet NZBC F8



Pictogram Double Arrow
Exit right or left from here
Maximum Viewing Distance: 16 metres
Product No: S20-RMRL2916-16m
Double Sided: DSS20-RMRL2916-16m
Size 290mm x 162mm



Pictogram Double Arrow
Exit right or left from here
Maximum Viewing Distance: 24 metres
Product No: S20-RMRL4223-24m
Double Sided: DSS20-RMRL4223-24m
Size 420mm x 230mm



No Exit
Do not use this door to exit in an emergency
Maximum Viewing Distance: 16 metres
Product No: S20-NE4113-16m
Size 410mm x 133mm

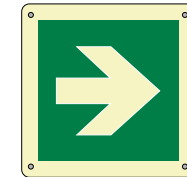

Arrow
Travel in this direction
Product No: S20-AR1313
Size 133mm x 133mm
For use with: S20-EX2313-16m

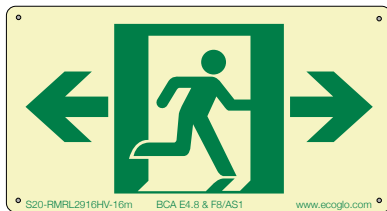

Pictogram Double Arrow Hi Vis
Exit right or left from here
Maximum Viewing Distance: 16 metres
Product No: S20-RMRL2916HV-16m
Double Sided: DSS20-RMRL2916HV-16m
Size 290mm x 162mm

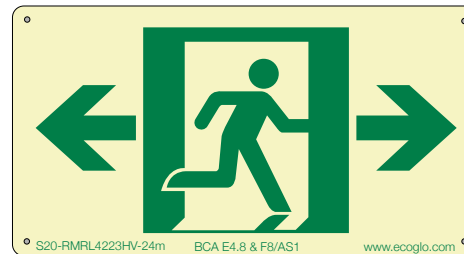

Pictogram Double Arrow Hi Vis
Exit right or left from here
Maximum Viewing Distance: 24 metres
Product No: S20-RMRL4223HV-24m
Double Sided: DSS20-RMRL4223HV-24m
Size 420mm x 230mm

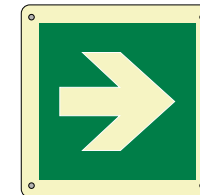

Arrow
Travel in this direction
Product No: S20-AR1616
Size 162mm x 162mm
For use with: S20-RM1616-16m and S20-EX2916-24m

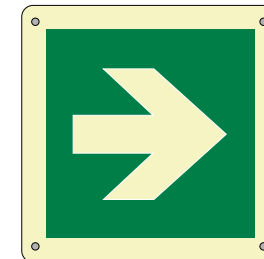

Arrow
Travel in this direction
Product No: S20-AR2323
Size 230mm x 230mm
For use with: S20-RM2323-24m

Mounting Brackets

Side and Top Mounting Brackets

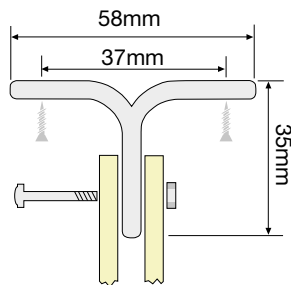

| PRODUCT CODE | PRODUCT NAME | CEILING MOUNT BRACKET | WALL MOUNT BRACKET |
|----------------------|----------------------------------|-----------------------|--------------------|
| S20-RM1616-16m | Pictogram Uni | B1-162 | B1-162 |
| S20-RM2323-24m | Pictogram Uni | B1-230 | B1-230 |
| S20-RM2916-16m | Pictogram | B1-290 | B1-162 |
| S20-RM4223-24m | Pictogram | B1-420 | B1-230 |
| S20-RM2916HV-16m | Pictogram Hi Vis | B1-290 | B1-162 |
| S20-RM4223HV-24m | Pictogram Hi Vis | B1-420 | B1-230 |
| S20-RMR2916-16m | Pictogram Right | B1-290 | B1-162 |
| S20-RMR4223-24m | Pictogram Right | B1-420 | B1-230 |
| S20-RML2916-16m | Pictogram Left | B1-290 | B1-162 |
| S20-RML4223-24m | Pictogram Left | B1-420 | B1-230 |
| DSS20-RMD2916-16m | Double Directional | B1-290 | B1-162 |
| DSS20-RMD4223-24m | Double Directional | B1-420 | B1-230 |
| S20-RMRL2916-16m | Double Arrow | B1-290 | B1-162 |
| S20-RMRL4223-24m | Double Arrow | B1-420 | B1-230 |
| DSS20-RMRL2916-16m | Double Arrow Double Sided | B1-290 | B1-162 |
| DSS20-RMRL4223-24m | Double Arrow Double Sided | B1-420 | B1-230 |
| S20-RMRL2916HV-16m | Double Arrow Hi Vis | B1-290 | B1-162 |
| S20-RMRL4223HV-24m | Double Arrow Hi Vis | B1-420 | B1-230 |
| DSS20-RMRL2916HV-16m | Double Arrow Hi Vis Double Sided | B1-290 | B1-162 |
| DSS20-RMRL4223HV-24m | Double Arrow Hi Vis Double Sided | B1-420 | B1-230 |
| S20-EX2313-16m | Exit | B1-230 | B1-133 |
| S20-EX2916-24m | Exit | B1-290 | B1-162 |
| S20-EE6128-16m | Emergency Exit | B1-610 | B1-280 |
| S20-EE7835-24m | Emergency Exit | B1-785 | B1-350 |
| S20-NE4113-16m | No Exit | B1-410 | B1-133 |
| S20-AR1313 | Arrow | B1-133 | B1-133 |
| S20-AR1616 | Arrow | B1-162 | B1-162 |
| S20-AR2323 | Arrow | B1-230 | B1-230 |

Mounting Chain

Chain Suspension for Signs

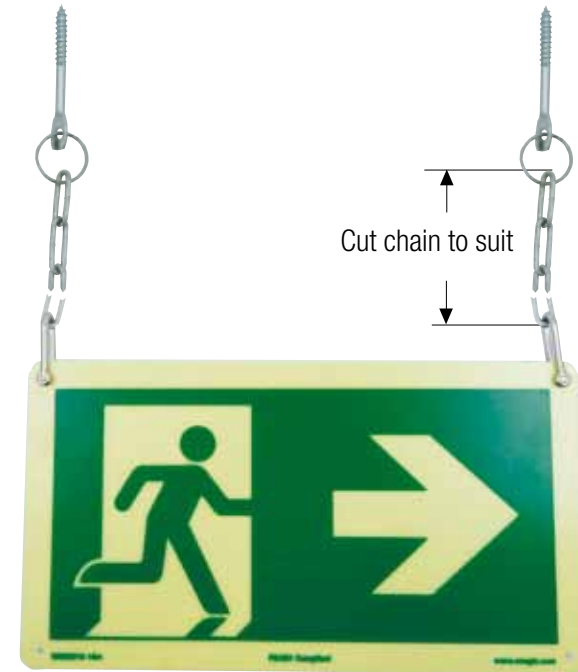

Chain available in 1 metre, 2 metre and 3 metre lengths

Escape Route Products to meet **F6 Visibility** in Escape Routes



F4-171 Step Nosing 68mm x 33mm

Available in standard lengths from 600mm to 1500mm in 100mm increments

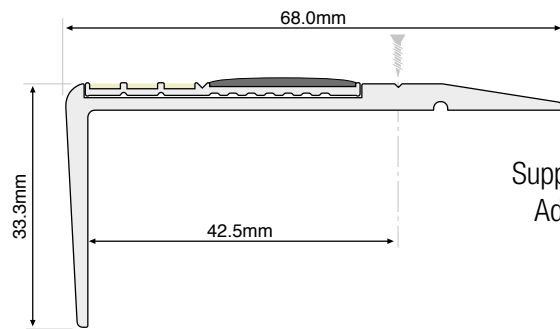
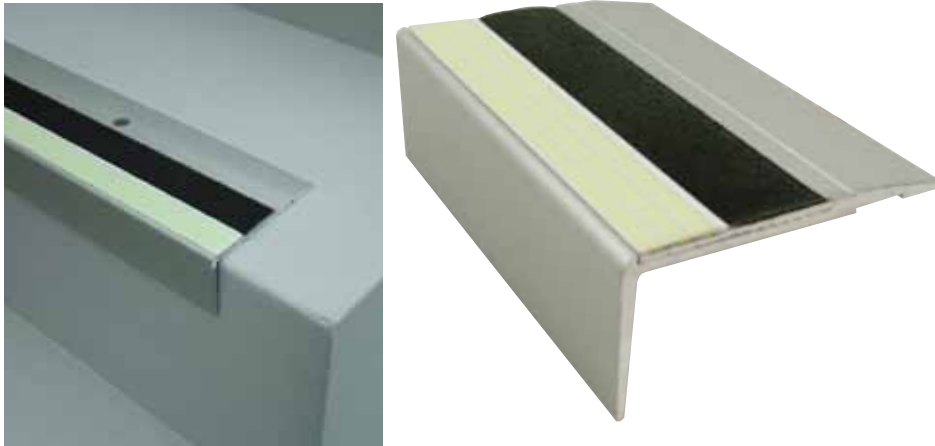

Supplied pre-drilled with fixers.
Adhesive and caulking gun
available separately

E2-071 Step Edge Contrast 37mm

Available in standard lengths from 600mm to 1500mm in 100mm increments

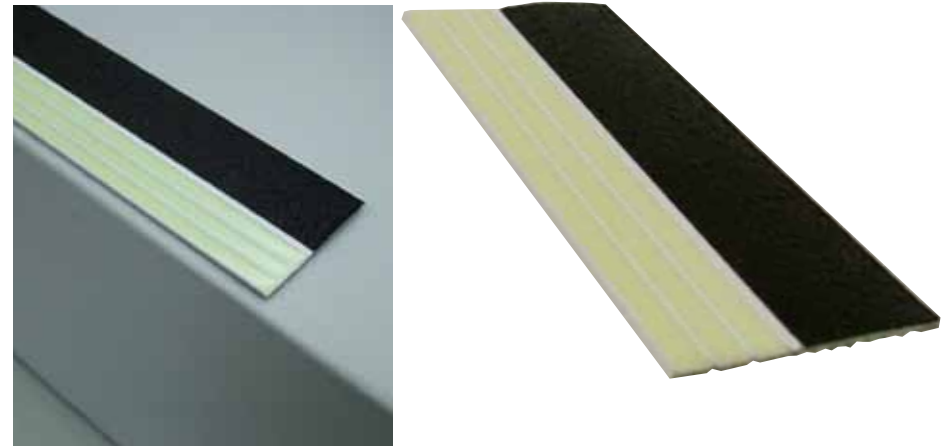

E2-071 Polyurethane adhesive fixing
E2-071P Punched for screw fixing

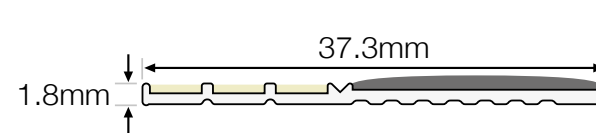

Adhesive and
caulking gun
available separately

Escape Route Products to meet **F6 Visibility** in Escape Routes



F4-G111 Step Nosing 68mm x 33mm

Available in standard lengths from 600mm to 1500mm in 100mm increments

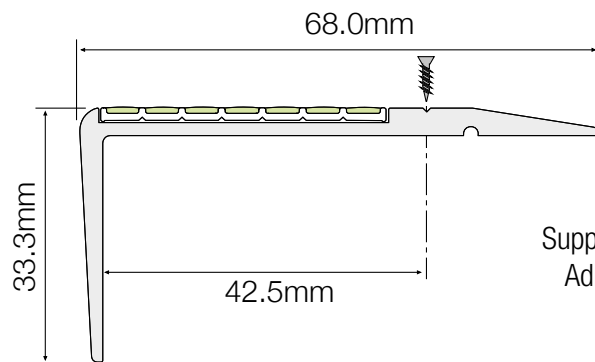
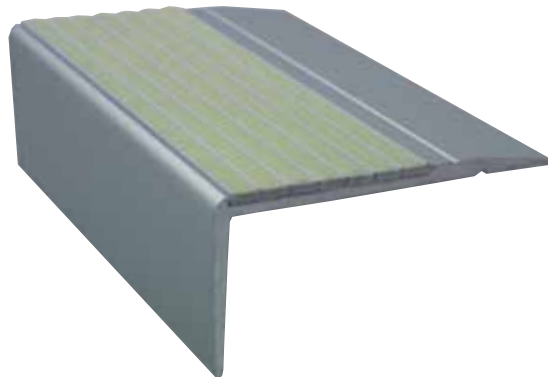

Supplied pre-drilled with fixers.
Adhesive and caulking gun
available separately

G8-011 Step Edge Composite 37mm

Available in standard lengths from 600mm to 1500mm in 100mm increments



G8-011 Polyurethane adhesive fixing
G8-011P Punched for screw fixing

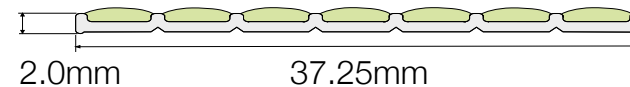

Adhesive and
caulking gun
available separately

Escape Route Products to meet **F6 Visibility** in Escape Routes



F14-175 Step Nosing 85mm x 10mm

Available in standard lengths from 600mm to 1500mm in 100mm increments

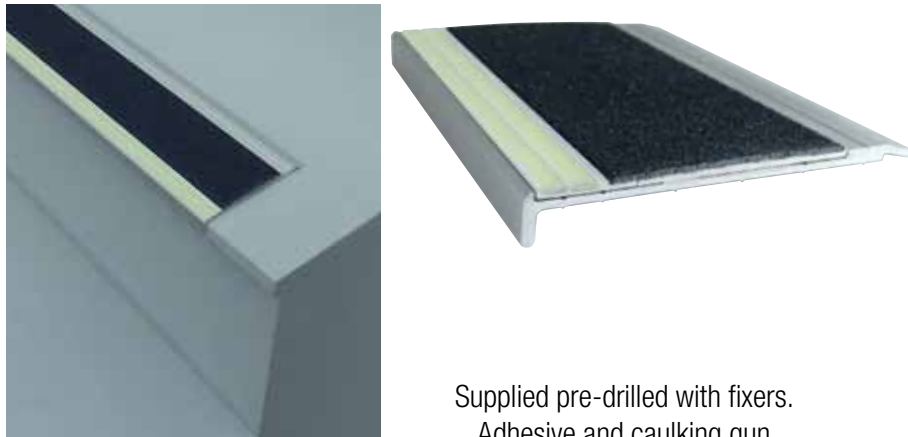

Supplied pre-drilled with fixers.
Adhesive and caulking gun
available separately

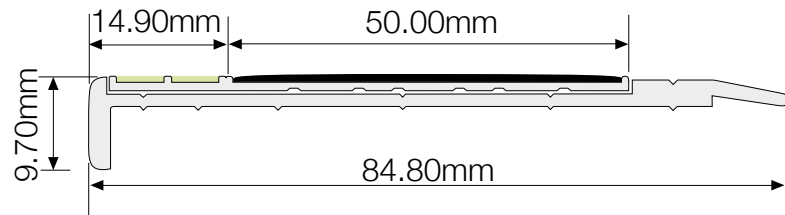

E14-075 Step Edge Contrast 64mm

Available in standard lengths from 600mm to 1500mm in 100mm increments



E14-075 Polyurethane adhesive fixing
E14-075P Punched for screw fixing

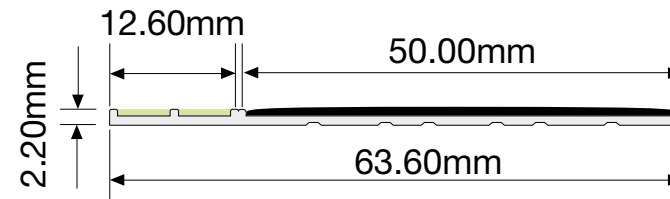

Adhesive and
caulking gun
available separately

Escape Route Products to meet **F6 Visibility** in Escape Routes



MS-26 Handrail Wall Strip 26mm

Available in 1000mm lengths

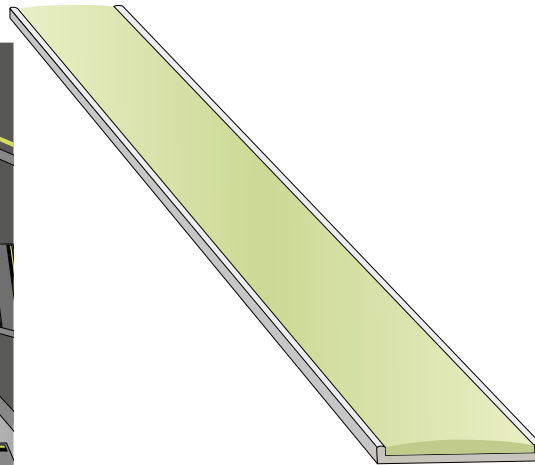
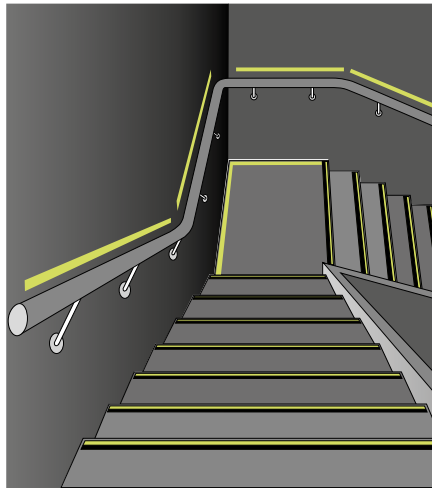

MS-26T-1000 Release tape pre-fitted

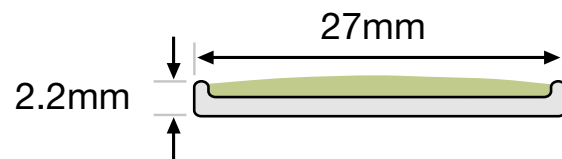

H3-001 Handrail Marker 16mm

Available in 1000mm and 1500mm lengths



H3-001T-1000 Release tape pre-fitted
H3-001T-1500 Release tape pre-fitted

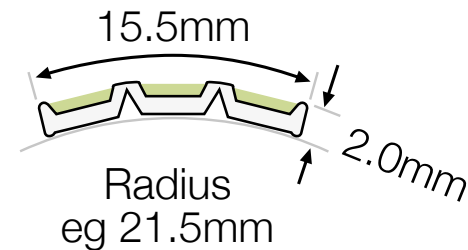

Escape Route Products to meet **F6 Visibility** in Escape Routes



G3-001 Guidance Strip 16mm

Available in 1000mm lengths



G3-001-1000 Polyurethane adhesive fixing
G3-001P-1000 Punched for screw fixing
G3-001T-1000 Release tape pre-fitted

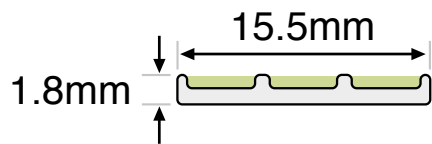

G4-001 Guidance Strip 12.5mm

Available in 1000mm lengths



G4-001-1000 Polyurethane adhesive fixing
G4-001P-1000 Punched for screw fixing
G4-001T-1000 Release tape pre-fitted

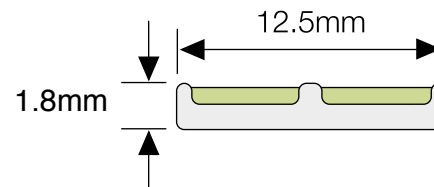

Escape Route Products to meet **F6 Visibility** in Escape Routes



T5-101 Path Marker

Available in 1000mm lengths

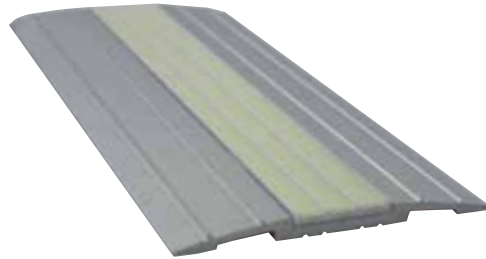

T5-101-1000 Polyurethane adhesive fixing
T5-101P-1000 Punched for screw fixing

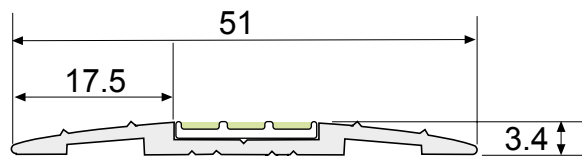

T6-101 Path Marker

Available in 1000mm lengths



T6-101-1000 Polyurethane adhesive fixing
T6-101P-1000 Punched for screw fixing

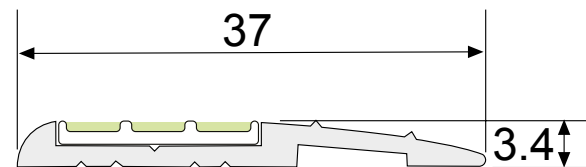

Escape Route Products to meet F6 Visibility in Escape Routes



G7-100 Solaris Path Marker

Available in 100mm lengths

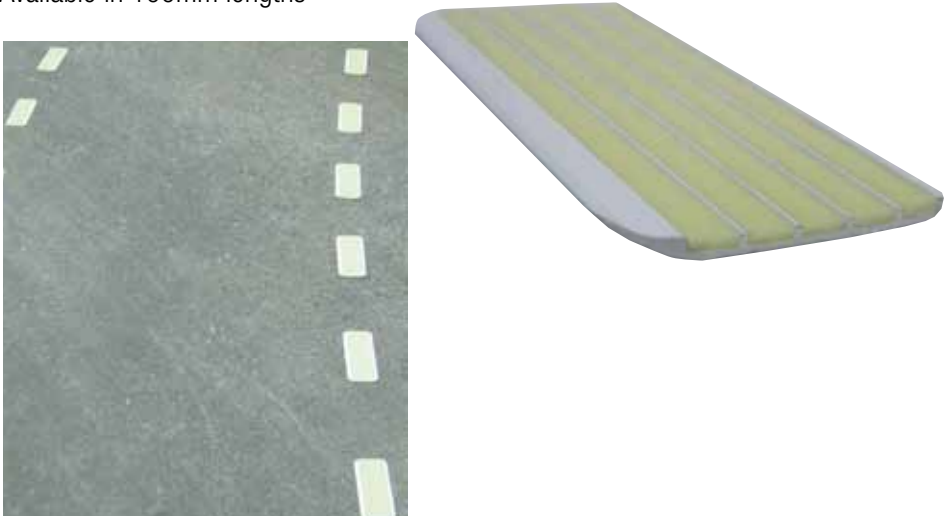

G7-100 Polyurethane adhesive fixing
G7P-100 Punched for screw fixing
G7T-100 Release tape pre-fitted

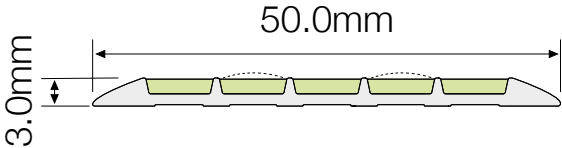

Door Handle Marker

Use this to highlight a door handle in an emergency

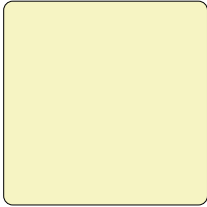

60mm x 60mm

SQ60 - Release tape pre-fitted

Adhesives

Adhesive for Escape Route Products



Caulking Gun

CLKGUN-600ml

To take 600ml Adhesive Sausage



Pricing available on request

Polyurethane Adhesive

BSKSNF-600ml



Pricing available on request



Ecoglo International Limited

77 Kingsley St, Christchurch,

Phone: +64 3 348 3781,

Email: info@ecoglo.com

www.ecoglo.co.nz

2 CODES - ONE SOLUTION*

Attention Designers & Project Managers

Ecoglo has the solution for both safety step nosing and emergency lighting with the one quality product.

* Satisfy both NZBC D1 and F6 codes with Ecoglo Step Nosing and save your client costs

D1.3.3. (g) Have stair treads with a leading edge that can be easily seen
F6.2 Specified features must be reasonably visible by a lighting system, other systems or both, during the failure of the main lighting.

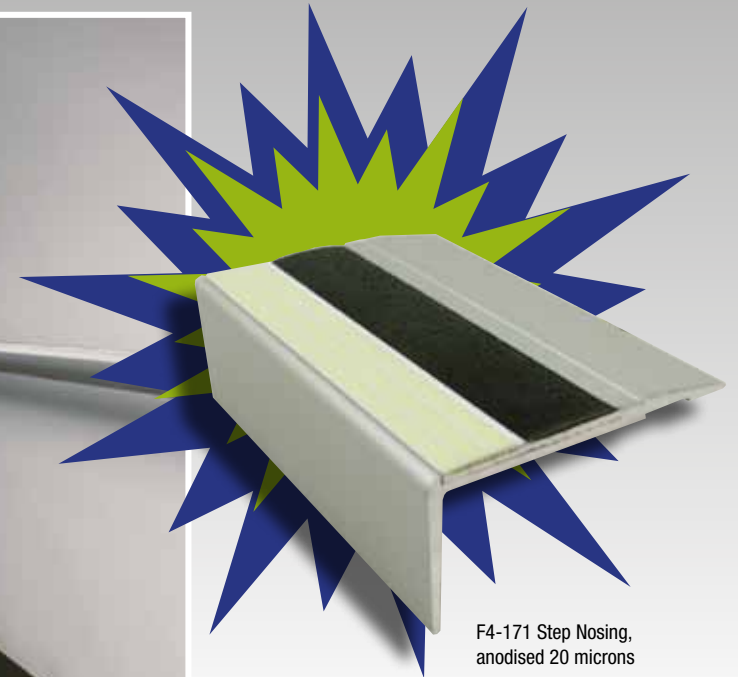

F4-171 Step Nosing,
anodised 20 microns

 **ecoglo**[®]

VISIBLY BETTER

Ecoglo International Limited
77 Kingsley St, Christchurch,
Phone: +64 3 348 3781,
Email: info@ecoglo.com
www.ecoglo.co.nz